

The ALLEGHENY NEWS

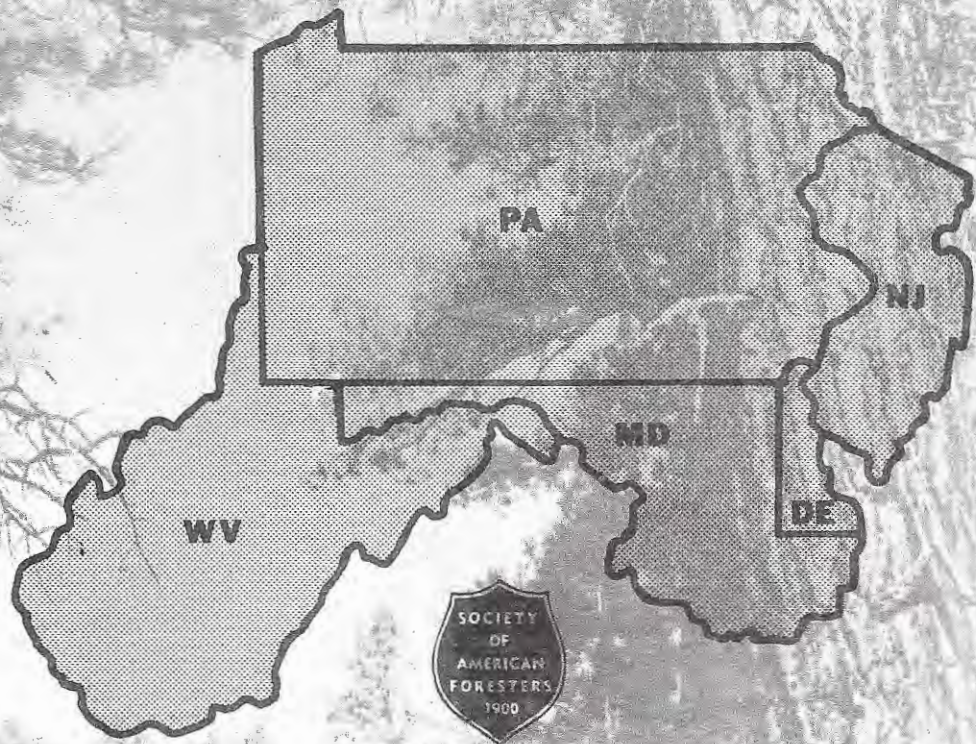

This issue contains:

**SUMMER SECTION MEETING PREVIEW:
AUGUST 29—31, CANAAN VALLEY, W. VA.**

ABSTRACTS FROM WINTER MEETING AT VALLEY FORGE —

**"WHY A TREE FARM" BY ROBERT W. KARN, SR.
"SUMMARY OF MYTH OF THE SMALL WOODLOT"
BY ROBERT S. BOND**

**HERBICIDE TREATMENT OF FERN AND
GRASS UNDERSTORIES WITH ROUNDUP:
A NEW TOOL IN ALLEGHENY HARDWOOD
SILVICULTURE BY STEPHEN B. HORSLEY**

**NEWS FROM AROUND THE SECTION AND
THE NATIONAL SCENE**

SUMMER 1979

Allegheny News

CHAIRMAN

GEORGE R. KEMP, 633 Long Run Road, McKeesport, Pa. 15132

VICE CHAIRMAN — CHAIRMAN ELECT — MEMBERSHIP CHAIRMAN

KENNEY P. FUNDERBURKE, JR., P. O. Box 685, Lewisburg, W. Va. 24901

SECRETARY/TREASURER

RICHARD A. KENNEL, 713 Oxford Lane, Wallingford, Pa. 19086

EXECUTIVE COMMITTEE

FOREST POLICY COMMITTEE CHAIRMAN

ROBERT T. FORNEY, 2015 Mona Court, Milton, W. Va. 25541

LEGISLATIVE COMMITTEE CHAIRMAN

JAMES E. PFLIEGER, Route 2, Box 149, Fayetteville, Pa. 17222

FOREST SCIENCE COORDINATOR

WILLIAM D. SCHERER, Route 1, Box 757, Frostburg, Md. 21532

PUBLIC AFFAIRS COMMITTEE CHAIRMAN

BRUCE A. SCHICK, 223 East Washington Street, Lewisburg, W. Va. 24901

PAST PRESIDENT

JAMES C. NELSON, 1295 Kelton Road, Camp Hill, Pa. 17011

EDITOR

ROXANN WALCUTT, Allegheny News, Box 452, Smethport, Pa. 16749



The Allegheny News is published three times a year by the Allegheny section of the Society of American Foresters.

Its circulation reaches more than 1200 members.

SUMMER BREAK

By the length of this issue's column, you can see that there hasn't been a lot of activity on my part since the Winter meeting. A year ago, there was a scurry to get my committees and programs jelled. Also, the national scene took considerable time with regard to the proposed Society reorganization and the mid-year summer HSD meeting, which took place in St. Louis a year ago. Things are rather quiet at this point.

The House of Section Delegates decided to forego a mid-year meeting inasmuch as routine business could be handled by mail and the initial impact of the proposed referendum and later action. Environmental and forestry issues still continue, and our Section constituency can be brought aware of these through the Allegheny News and the Journal. The Section members have the vehicle of responding through section, chapter, and the standing committees within the Allegheny Section. Let us hear from you.

We are proceeding on course to have an exciting Summer meeting hosted by the West Virginia Chapter in Canaan Valley State Park. This issue contains all of the details. In addition to being a "super" social outing and an opportunity for the recreationists to cap-off the summer season at "Wild and Wonderful", we will have an indepth technical program transcending the issues of wilderness and the controversial Blackwater Lake/Davis Power Project in the Canaan Valley. I'm planning on taking my family to Canaan, and if enough of us do it, I'm sure the West Virginia Chapter will host us in their typical mountaineer fashion.

It won't be long until my second year comes to an end. The nominating committee will be looking for excellent candidates for the next two years. This committee, headed by past president Jim Nelson will be entertaining suggestions from chapters and other sources. We will be electing a new chairman-elect and executive committee.

The 1980 Winter meeting will be held in Western Pennsylvania, hosted by the new Western Gateway Chapter. I'm still looking for a program format and some volunteers to work on that. As I mentioned in the last News, I feel led to follow-up with a practical symposium surrounding the interfaces of the forester with the public; i.e., the logger, the recreationist, the community leaders, etc. Any ideas? Any volunteers?

Not much more to report. Looks like a great summer. We hope to see most of you at Canaan. Hang in there, good buddies. May God continue to bless your lives.

*George R. Kemp, Chairman
Allegheny Section*

HERBICIDE TREATMENT OF FERN AND GRASS UNDERSTORIES WITH ROUNDUP: A NEW TOOL IN ALLEGHENY HARDWOOD SILVICULTURE

by Stephen B. Horsley, Research Plant Physiologist, NEFES, Warren, Pa. 16365

Dense understories of hay scented fern, New York fern, and short husk grass are common in many Allegheny hardwood stands. In some stands they appear to be naturally abundant; in others they are the result of past thinnings that stimulated spread. Many of these stands lack adequate reproduction to qualify for clearcutting and on poorly drained sites shelterwood cutting stimulates the spread of ferns and grass.

In a series of studies we have demonstrated that herbaceous understories, particularly of hay scented or New York fern, seriously interfere with survival and growth of black cherry, red maple, sugar maple and other species of Allegheny hardwood reproduction. Stands with a herbaceous groundcover have 50 to 80 percent fewer seedlings. Seedling growth is also poor even if the overstory is completely removed. Such stands have a high probability of regeneration failure if cuttings are made in them.

In stands that lack adequate advance regeneration, but have more than 30 percent groundcover of fern or grass on more than 30 percent of the sample plots in the stand, it is necessary to remove or substantially reduce the herbaceous groundcover before harvest cutting. It now appears possible to combine two recent developments in Allegheny hardwood silviculture to regenerate such stands: 1) herbicide treatment of the herbaceous understory to remove interfering plants followed by 2) shelterwood cutting to provide environmental conditions favorable for seed production, germination, and establishment of desirable Allegheny hardwood species.

Since 1976, we have been studying the use of herbicides to control fern and grass understories in Allegheny hardwood stands. In these studies we tested a number of chemicals to determine the optimum rate and time of application and residual effects on dormant tree seed stored in the litter and growth of planted seedlings.

Of the chemicals we tested, Roundup¹ manufactured by Monsanto Agricultural Products Co., was the most effective chemical, biologically and economically. Roundup is a broad spectrum, non-residual herbicide with low toxicity to humans, test animals, and soil microorganisms. One pound active ingredient (one quart of product) per acre applied from late July to early September, resulted in 90 (grass) to 100 (fern) percent control of ferns and grass at the end of two growing seasons. Roundup had no adverse effect on germination of dormant seed stored in the litter or growth of black cherry seedlings planted to bioassay residual toxicity. The cost of Roundup in this test was \$15 per acre.

In 1977, we applied Roundup in a large plot study to test its use in a herbicide - clearcut and a herbicide - shelterwood cut sequence. The stand we selected had a dense continuous groundcover of hay scented fern. Roundup was applied in August with a backpack sprayer; cuttings were made the following winter.

Roundup treatment resulted in nearly complete kill of the fern understory. Much of the advance reproduction present was, of course, also killed, but during the following growing season, new reproduction developed from dormant cherry seed in the litter and cherry and red maple seed crops. Reproduction on clearcut plots was primarily black cherry, whereas large numbers of cherry and red maple were found on shelterwood cut plots. Substantially larger numbers of seedlings became established on shelterwood cut plots than on clearcut plots. Hence, it appears that the herbicide - shelterwood cut sequence provides a better opportunity to establish large numbers of advance seedlings prior to final harvest cutting.

Until recently, Roundup has not been labeled for forestry use, although it is registered for use in controlling weeds of agricultural crops and for non-cropland use. Monsanto is now in the process of applying for an EPA registration for forestry use. In the interim, Roundup has recently been registered for forestry use in Pennsylvania (it is not registered for use in other states in the Section).

This summer, in cooperation with the Allegheny National Forest, Hammermill Paper Co., Pennsylvania Department of Environmental Resources, Texas-Gulf, and Monsanto are planning to apply Roundup in a semi-commercial herbicide - shelterwood cut sequence at 10 locations. In this study we plan to test the effectiveness of the herbicide - shelterwood cut sequence over a variety of sites, gather cost data and gain experience with mechanized ground application technique.

It appears that combining herbicide treatment of fern and grass understories with shelterwood cutting will be a useful technique in regenerating formerly difficult-to-regenerate Allegheny hardwood stands.

CAUTION ABOUT PESTICIDES *This publication reports research involving pesticides. The uses discussed here have not been registered in all states. All uses of pesticides must be registered by appropriate State and/or Federal agencies before they can be recommended.*

CAUTION: *Pesticides can be injurious to humans, domestic animals, desirable plants, and fish or other wildlife - if they are not handled or applied properly. Use all pesticides selectively and carefully. Follow recommended practices for the disposal of surplus pesticide and pesticide containers.*

¹Mention of a trade name does not constitute endorsement by the USDA Forest Service.



NATIONAL SCENE

COUNCIL POLICY ACTIONS AT SPRING MEETING

At its meeting May 2-3 at the Gifford Pinchot Forestry Building, the Council took several actions on SAF policy and governance issues, including the adoption of proposed Constitution and By-Law changes that would take effect under SAF's proposed reorganization. All of the recommendations, covering items ranging from terms of officers to boundaries for proposed science regions, will appear in the August Journal of Forestry together with the reorganization proposals and procedures to implement them. Ballots and background materials for the reorganization referendum will be mailed to members this September. The Council, however, delayed until its fall meeting consideration of a proposed referendum on voting status for technician members. The Council directed the staff to draft referendum and background materials, including information from the 1978 Member Opinion Survey and pertinent correspondence.

Dues Adjustment -- Approved a recommendation to make no dues adjustment for 1980.

2, 4, 5-T Controversy
Background information was presented to the Council regarding the recent EPA ban of 2,4,5-T for forestry applications. The Council concluded that SAF could offer information to EPA regarding the benefits derived from 2,4,5-T's use, but doubt was expressed about SAF's ability to address the public health issues. A letter will be sent to EPA expressing concern about the abandonment of the RPAR process and the inconsistent application of the 2,4,5-T ban.

RARE II LEGISLATION Recent developments regarding the U.S. Forest Service's wilderness review were discussed, and several options for future SAF involvement were explored. The Council directed the staff to prepare a general position on the RARE II legislative process. The creation of a national task force to advise the Council on RARE II legislation was also approved. Finally, the Council resolved that positions on specific proposed wilderness, non-wilderness and further study areas should originate from Sections and Chapters -- units of SAF closest to the areas under consideration.

FEDERAL REORGANIZATION The report of the SAF task force studying federal reorganization was accepted by the Council. It will be published in the June, 1979, Journal of Forestry. Further action concerning federal reorganization was postponed, pending receipt of a detailed legislative proposal from the Administration. Subsequently, the Administration abandoned its proposal to create a Department of Natural Resources.

SAF SEEKS COOPERATIVE POLICY EFFORTS WITH OTHER RESOURCE PROFESSIONALS

SAF has commenced discussions with representatives of the Society for Range Management (SRM) and the American Fisheries Society to explore ways to work more

closely on natural resources issues. In a recent meeting at the SAF national office, a range of issues -- including NFMA and Clean Air Act regulations -- were identified as promising first steps.

SAF will send a representative to SRM's annual meeting in Pocatello, Idaho, in July to explain SAF's resource policy programs and discuss the potentials for future joint efforts.

.....

SAF — G.A.O. MEETING ON FOREST TAXATION OF N.I.P.F.'s

On April 26, 1979, Thomas Bicknell and Marvin Burch of the U.S. General Accounting Office (GAO) met with Clark Row (USFS) and Robert Day (SAF) to discuss forest taxation. GAO is preparing an assessment for Congress of how current tax laws are affecting forest management in the United States.

The focus of the meeting at the SAF national office was on non-industrial, private forest landowners. Subjects discussed included: investment tax credits, expensing forest management costs, capital gains, and landowner assistance programs. Completion of the GAO report is expected this fall.

.....

REPORT AVAILABLE ON N.I.P.F.'s

Since publishing its study report on nonindustrial private forests in March, 1979, SAF has sold over 2,000 copies in bulk quantities. Purchasers have included: universities, state forestry agencies, forestry extension offices, forest industry associations, an Oregon bank, and the U.S. Forest Service.

Copies of the report are still available as advertised in the Journal of Forestry. Contact John Schmidt, SAF.

BROMLEY NAMED AT SAF

W. S. Bromley, former executive vice president of the American Pulpwood Association (APA), has been appointed as the new acting executive vice president of the 21,000 member Society of American Foresters (SAF).

Bromley was APA's chief executive for most of his 25 years with the Washington, D.C. based association before his retirement in 1974. Earlier in his career, Bromley served with the Ohio Division of Forestry, the U.S. Forest Service, University of Michigan, and Cleveland Cliffs Iron Company. He earned his B.S. in Forestry from Pennsylvania State University and a M.F. degree from Yale.

M. B. Dickerman returned to his private consulting practice in Washington, D.C. after six months as SAF's acting head.

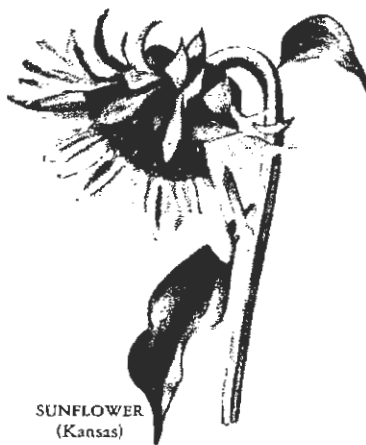

SUNFLOWER
(Kansas)

NEW SAF FILM "THE SOUTH'S AMAZING FORESTS"

"The South's Amazing Forests," a 21 minute film produced jointly by SAF and the U.S. Forest Service, has been shown at 500 screenings throughout the United States since its November, 1976, premier at the SAF national convention in New Orleans, La. The Forest Service says an estimated 25,000 persons have seen the production, which recounts how forest management in America's Southland has actively turned once abandoned timberland into a productive resource for man and wildlife. An agency spokesman says audience response has been "very good for a regional film of this type," noting that the film has been seen by civic groups, high school science classes, visitors to local agencies, and training sessions. The Southern Forest Institute, a primary regional distributor of the film, says the film has been further distributed by forest industry, and has also been used by southern television stations and an advertising agency.

Copies of the film are available on loan for SAF meetings and public affairs functions through most southern national forests, or from the Office of Information, U.S. Forest Service Southern Region, 1720 Peachtree Road, N.W., Atlanta GA 30309, telephone 404/881-4191.

SAF'S BOSTON CONVENTION — AN EYE ON THE 80s

This fall, some 1,500 people will hold a town meeting in the middle of Boston's busy downtown district. You're invited -- to SAF's 1979 National Convention, October 14-17, at the Boston Park Plaza Hotel. Members there will take a rare look at America's urban lifestyle, its effects on forestry, and also visit the local forestry attractions of New England.

Keynote speaker Patrick J. Leahy, U.S. Senator from Vermont, will lead a distinguished list of commentators who will explore the changing face of forestry in the 1980's, and shed new light on such professional controversies as dominant-use versus multiple-use management, and the merits of specialization versus generalization in a changing profession. Renowned ecologist and writer Rene Dubos, professor emeritus at Rockefeller University, will address the convention banquet on Wednesday, October 17.

The meeting will coincide with New England's brilliant splash of fall colors, which will be a special attraction during the various scenic and forest management tours of Connecticut, Maine, Massachusetts, New Hampshire, and Vermont. Watch the July Journal for the full convention program, plus a special story on the delights Boston has to offer. Registration packets will be in the mail later that month.

A town meeting in Boston -- don't miss it!

SAF NOW ACCEPTING NOMINATIONS FOR SIR WILLIAM SCHLICH MEMORIAL AWARD

The SAF national office solicits your nominations for the Sir William Schlich Memorial Award to be given in 1979. This award recognizes broad and outstanding contributions to forestry with emphasis toward, but not limited to, policy, and national or international activity.

Here is a list of previous honorees:

Franklin D. Roosevelt	1935	Clyde S. Martin	1960
Gifford Pinchot	1940	Richard E. McArdle	1962
Henry S. Graves	1944	Henry Schmitz	1964
William B. Greeley	1946	George A. Garratt	1966
Herman H. Chapman	1948	Charles A. Connaughton	1968
Ralph S. Mosmer	1950	Philip R. Wheeler	1970
Elwood Wilson	1952	Richard J. Preston, Jr.	1972
Tom Gill	1954	DeWitt Nelson	1974
Samuel T. Dana	1956	Kenneth P. Davis	1976
G. Frank Heintzleman	1958	William E. Towell	1978



OUR GIRLS ARE SPECIAL

**Beth's
Toll Free
Special**



SILVA
RANGER
TYPE 15 **HAND
COMPASS**

WORLD'S FINEST, LIQUID FILLED
• DECLINATION OFFSETTING DEVICE
• TRANSPARENT PROTRACTING PLATE
• SIGHTING MIRROR • TRANSPARENT
HOUSING • INCH AND MILLIMETER
SCALE

#1019205 STANDARD GRADUATED 0-360° \$30.00
or #1019225 DIAL GRADUATED
IN QUADRANTS 0-90° \$30.00
BETH'S DISCOUNT - 6.90
\$23.10



**Pat's
Toll Free
Special**



**SNAKE
PROTECTIVE
LEGGINGS**

WORLD'S MOST COMFORTABLE. ONE SIZE FITS
ALL. BRONZE MESH COVERED WITH WATER
REPELLENT OLIVE DRAB CANVAS.

#130460S \$22.50
PAT'S DISCOUNT - 5.83
\$16.67



**Sarah's
Toll Free
Special**



**HEDGE
SHEARS**

DELUXE HOLLOW GROUND CUTLERY STEEL
BLADES. BALL BEARINGS FOR EASY CUTTING
ACTION. BUILT-IN SHOCK ABSORBERS
FOR COMFORTABLE HANDLING.

#153400S \$28.95
SARAH'S DISCOUNT - 5.00
\$23.95

OFFERS EXPIRE AUGUST 30, 1979
ORDER TOLL FREE 1-800/241-6401
(IN GEORGIA, ALASKA, AND HAWAII CALL COLLECT 1-404-455-0907)

EQUIPMENT SUPPLIER AND CONSULTANT TO PROFESSIONALS THROUGHOUT THE WORLD



Ben Meadows Company

3589 Broad Street, Atlanta (Chamblee), Georgia 30366
Telephone 404/455-0907 Cable Address "Benco"

5852 A

Nominations need not follow a specific format, but should be concise, factual biographies not to exceed 300 words.

Candidates will be screened by the Committee on Professional Recognition and selection of the winner will be made by the Council at its Fall meeting. The recipient will receive the award at the following year's national convention. To allow time for careful committee staff work, nominations should be received in national headquarters no later than August 15, 1979.



FOREST POLICY REPORT

Federal issues involving the forestry profession continue to command highlight attention in the form of President Carter's "Federal Department Reorganization" plan as it affects the USFS and the "Civil Service Reform Act of 1978".

Recent information at the time this report was written indicates that the Administration's plan to create a consolidated Department of Natural Resources has run headlong into some strong congressional opposition. As proposed, the Department of Natural Resources would employ some 89,800 persons with a budget of some \$7.4 billion. The justification for the reorganization is capsulized in the following three summary statements.

- Better Management of America's Natural Resources
- Reduced Red Tape
- Reducing Administrative Costs

These statements are defined and expanded in typical political rhetoric but keep the concepts in mind when considering the implications of the Civil Service Reform Act of 1978. "Focus On The Issues" by Robert D. Day, Jr., May 1979 Journal gives a detailed summary of the Reform Act. It is interesting to note that this act creates a Senior Executive Service (SES) in the civil service structure with compensation rates ranging from \$44,756 (GS-16) to \$52,800 (Executive Level IV). However, the SES will include two types of employment positions defined as "career reserved" and "general". The proposed staff organizational chart as listed in the Journal article and recommended by the Secretary of Agriculture for the USFS designates only one top level position (Deputy Chief Administration) as career reserved. All general positions would be subject to political patronage appointments.

It is my personal opinion that conflicting objectives are implied herein and hopefully this dialogue will stimulate your own conclusions.



Bob Forney
Forest Policy Committee

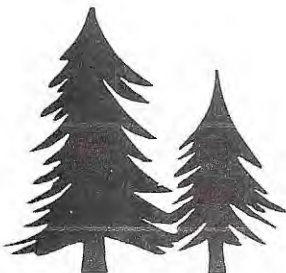

a handful of PRODUCTIVITY...

the RELASKOP

It's an angle gauge,
a tree caliper,
a clinometer
and a
rangefinder -
ALL IN ONE
COMPACT
INSTRUMENT!

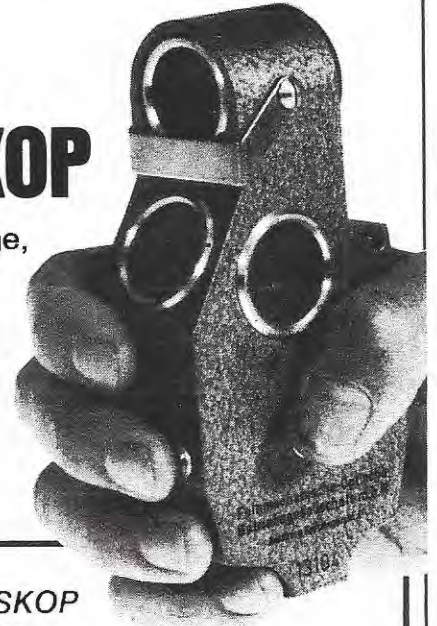

*With the RELASKOP
you can measure...*

- Basal Area** - in square feet per acre or square meters per hectare.
- Tree Diameter** - outside the bark at any height; in inches or centimeters.
- Tree Height** - in feet or meters.
- Vertical Angles** - in degrees, percent and topographic or 20, 25, 30 meters scales.
- Horizontal Distances** - ranges of 33, 66, 99 or 132 feet or 15, 20, 25, 30 meters.

RELASKOP data are STX computer programmable - write for information.

Put a RELASKOP in your hands. See what it can do for you!

Complete details in Catalog No. 29 - free on request.

Order your RELASKOP from



**Forestry
Suppliers,
Inc.**
205 West Rankin Street
Post Office Box 5397
Jackson, Mississippi 39204

Phone 1-601-354-3565



Looking Back

There have been a lot of excellent summer meetings, both technical and historical, such as the one in New Jersey in September 1959 when we toured the then recently acquired Wharton Estate—a large addition to the State Forest. It was a brutally hot day, and the afternoon stop at Greenbank State Forest for a clam and champagne break, hosted by the New Jersey Chapter, nearly eclipsed, for some otherwise stalwart foresters, an excellent beef and lobster banquet at the Sweetwater Casino. Si Little told the group that afternoon that his research on honey-suckle control showed clearly that, “If you graze it the first year, treat it with herbicides the second year, and burn it the third year, it helps some.” Bill Phoenix and his committee, consisting of Jim Cumming, Si Little, John Richardson, Dick West, Sid Walker, Joe Vanaman, Tiny Cranmer, and Frank Wagner had a lot more than “Jersey ginger ale” and seafood on the program, but that stop on the field trip certainly provided a creative touch of hospitality and local flavor. Good thing it was last.

Just forty-five years ago, on September 6, 1934, the Allegheny and New York Sections met in joint session at the Rock View House in Montague, New Jersey. With a visit to Gray Towers as the first order of business on Thursday afternoon the meeting was off to a good start. There is no mention of Governor Pinchot being at the meeting, so we presume he was not.

The next day the bus left at 7 a.m. for a tour of the Stokes State Forest, two New Jersey Zinc Company tracts, a private woodlot, the Newark municipal watershed, and the 10,000 acre High Point Park, returning to the hotel after 5:30 p.m. There were eleven stops, presenting a variety of forest practices, but the foresters and their wives were not too tired, we read, to enjoy the banquet and program that evening, followed by “dancing and such other diversions as the casino (had) to offer.” Personal cars were used on Saturday for the Pennsylvania tour of Childs State Park, the Blooming Grove Hunting Club and Fish Hatchery, and Pimple Hill Fire Tower, with lunch (\$1.00) at Skytop Lodge. Lunch the day before, at Newfoundland, had been only 60¢. We are intrigued by this statement in the program announcement relating to the Pimple Hill stop, “This trip will be of particular interest because of the system now in vogue whereby so-called brush land is given controlled burning under the supervision of the State Forest officers for huckleberry production.” We’ll have to ask Henry Clepper or Clyde Pyle about that. They were among the Forests and Waters employees who helped make the arrangements for the meeting.

It takes courage to plan a meeting at which people know in advance the bus trip will take nearly eleven hours, but foresters are made of sturdy stuff. Under the leadership of Hume Frayer, our West Virginia brethren demonstrated that in 1946 as they rose to the challenge of hosting the first post-war summer meeting. “Forestry in the Hardwoods” was their theme when the Section met July 18 to 20 at the state 4-H Club camp near Weston. Perhaps the wage and price controls of that period influenced the thinking, but the meeting was scarcely underway when Gordon Mark presided over a panel

which addressed the topic, “Is regulation the next step to better practices in the hardwood forests?”

The records don’t tell us what was said or what conclusions, if any, were reached, but R. M. Evans, the Regional Forester; Slim Moore from New Jersey; Merwin Humphrey from Penn State; Luther Schnur, NEFES; W. O. Byrne, Virginia Extension Service (?); and Sel Tinsley, SCS in Upper Darby, were speakers, and 125 members and guests were present, including Section Chairman Jimmy Morton.

Who remembers what the Sally Saw was that Fred Simmons demonstrated the next day on the tour? Was it related to the white oak cooperage logging operation the group visited?

Small woodland management was part of the tour and was discussed and demonstrated by Dan Dunmire (the father, please note), then an SCS farm forester.

Not only were our Mountaineer colleagues courageous for accepting the task of scheduling the first meeting after the war years and for attacking regulation head-on, they also deserve special credit because Section Secretary-Treasurer Harry Dengler’s report tells us that it wasn’t until the morning of July 20, the final day of the meeting, that, “The newly-formed West Virginia Sub-section held its first official meeting.” Hume Frayer was elected Chairman, W. C. Percival Vice-Chairman, and R. K. Ziebarth Secretary-Treasurer.

No wonder our southernmost Chapter is strong. Not many groups can point to their first effort as being such an acknowledged success. Congratulations, West Virginia Chapter! At this year’s summer meeting we’ll help you celebrate your 33rd Birthday.

Bill Corlett
Section History Committee

A SUMMARY OF MYTH OF THE SMALL WOODLOT

Allegheny Section, Society of American Foresters, Winter Meeting, February 8, 1979



Robert S. Bond
Director, School of Forest Resources
The Pennsylvania State University

Essentially we view these owners as having goals which serve the public welfare, not their own. I cannot agree with Dick Thorpe's admonition that "the majority of his recommendations must be directed to the objective of making the landowner aware of the value of his small woodlot to more than himself."

This country's economic base was founded on Lockean Ideology according to George C. Lodge in his book, *The New American Ideology*. Briefly, this ideology favored: individualism, property rights, competition in the market place, a limited state (government) and scientific specialization. The non-industrial private forest owner exemplifies the ideologies of individualism and property rights. He would undoubtedly agree that the government should be limited in what it has to say about the property rights of individuals. I believe it is fruitless to try to convince the N.I.P.F. to do things for the public good.

Although many speakers said we don't know much about this landowner, it is evident that we know a lot more than we are willing to accept in working with them. Bill Towell has told us of AFA's efforts to learn about this group. Neil Kingsley has pointed out what the Forest Service Resources Evaluation Unit has been doing. In his paper he cited Stone's work in Michigan, only one of a host of studies made all over the country in the past 20 years on the subject of the small-acreage forest landowner. Robert Karn gave us a first-hand view of the N.I.P.F. Have we accepted these findings and put them to use in addressing the issue? I think not. We recognize their views but can't accept them and use them to our advantage.

Roger Sedjo mentioned his work with the jointly sponsored workshop of SAF and RFF in which the focus was on timber production, i.e., society goals and not those of the owner's themselves. He alluded to the current study of Marion Clawson. One thing that shows up in Clawson's work is that landowners are price responsive. They exhibit the Lockean Ideology in their response to the free-enterprise market place. Bill Roe stated "with the incentive of lower taxes and higher stumpage prices the small woodlot owner is becoming aware of his resource." One statistic Neil Kingsley gave was that in the Allegheny Section, 44% of the owners had incomes under \$10,000 annually. It is this group that will be most price responsive. But that does not give us more intensive forestry, it reduces the growing stock and its quality.

I thought John Oliver's perception of the public's viewpoint was interesting. He implied that many people view forestry as analogous to logging. Oliver and Roe, in their papers, both place the responsibility of and need for controlling cutting on the forester. Oliver says it is an obligation we have, while Roe looks at it as an economic opportunity in his consulting business, but also as something he feels is in the owner's interest and that of the public. How does the forester implement that responsibility?

Two papers -- Dick Thorpe's and Dave Kintner's -- put forth ways in which government and industry attempt to foster more intensive management. The problem is that not enough owners are responding. Kingsley's findings show that only 8% of owners utilized forestry assistance and 60% of the N.I.P.F.'s in the Allegheny Section area did not know where to get forestry assistance. With

As a summarizer of this day-long session, I want to pick up on the most pertinent points as I heard them and expand upon them.

I agree with Dick Thorpe and do not see the small woodlot as a myth--it is as real as anything ever was. Bill Towell's disagreement with calling it a woodlot is a matter of semantics, but his point that forest landownership means more to the owner than the production of wood, is well founded. Several speakers have substantiated this truth but for the most part the broader question of forest management as opposed to timber management has not been addressed.

As foresters we are concerned with the resource as it relates to society's needs, whether it be wood, recreation, or other goods and services. The Pinchot philosophy of the "greatest good for the greatest number in the long run" has stuck with the profession. When it comes to the non-industrial private forest owner, this philosophy causes problems. We perceived of the N.I.P. forest as supplying goods and services for the public good; mostly timber to fulfill future predicted needs. There is also the use of them for public recreation, such as for hunting and hiking.

A SUMMARY OF MYTH OF THE SMALL WOODLOT *(continued)*

all the efforts of government and private forest industry, this is an unbelievable figure! Why isn't our educational effort of informing the public about these services getting through to the forest landowners? One reason is that it is agriculturally focused, but nationally only 26 percent of N.I.P.F.S. are farmers. The group of people needing contact aren't watching public television's "Farm and Home Hour" or aren't up at 6 a.m. to hear the radio-tape made by the Service or Extension Forester. A little prime time is needed -- some "Smokey, the Bear" type publicity.

It does not seem to me that more intensive forestry will result by doing more of what we have been doing because we haven't been successful enough. Dick Thorpe listed things to improve the situation. I would like to reiterate the ones I feel might be most helpful.

1. Concentrate on the most productive available woodlands. Stop worrying about all of those millions of owners; they aren't all candidates for forest management.
2. Do more in market development, particularly for low quality hardwoods.
3. Provide a stronger and coordinated educational effort.
4. Most importantly, if we are to get owner's interest, then we need to focus on their goals, as varied as they are.
5. Gain greater respect by the public for logging operations. Educating loggers may do more good than educating landowners.

This brings me back to where John Lodge sees the business/social environment now, that is, the "New American Ideology." He points to "communitarianism" as opposed to individualism, to rights of membership compared to property rights and

community need instead of competition in the market place. I think you can recognize evidences of these things.

His other two ideologies are the ones that have a bearing on the direction to be taken with the N.I.P.F. owner. As Bill Towell stated: "If we, as professionals, fail to analyze and meet the needs of private, non-industrial forest lands and their owners, government regulation becomes a distinct possible alternative." In Lodge's "New American Ideology" he sees the state as planner and coordinator. This is the trend in forest and other natural resources/environmental areas. How far will it go, especially in relation to private forests?

The answer to that question in part depends on professional foresters. In Lodge's final comparative ideology he sees the need for holism in science, not scientific specialization and fragmentation. Foresters need to adopt the "holistic" view, not one of product specialization in dealing with N.I.P.F. owners. In other words, we need to consider the diverse goals of these owners in our attempt to better relate to them. If we do, I believe we will accomplish the major goal of increasing the supply of timber from these forest ownerships. It isn't a direct attack on the problem of most concern, but, like the salesman, it offers the foot in the door that is needed.

Robert S. Bond
Director, School of Forest Resources
The Pennsylvania State University



One thing surely hasn't been changin'—the need to tell the story of professional forest management, the need for the Foresters' Fund.

Through radio and television messages, audio-visual presentations, field trips for legislators and the press, the fund shows policymakers and the public what professional forestry is. Money to

finance these projects comes from interest earned by the fund. Money to increase the fund, in turn, comes from tax-deductible donations.

If you're pining for better public understanding of professional forest management, send a check to the Foresters' Fund, 5400 Grosvenor Lane, Washington, D.C. 20014.

Why A Tree Farm?

Allegheny Section Society of American Foresters Winter Meeting, February 8, 1979



Robert Karn, Sr.
Tree Farmer

The other day I was leafing thru my 1949 Ag Yearbook on Trees and came across a poem by Henry Abbey and I think it expresses the Tree Farmers thoughts.

*"What do we plant when we plant the tree?
We plant the ship which will cross the sea.
We plant the mast to carry the sails.
We plant the planks to withstand the gales.
The keel, the keelson, the beam, the knee.
We plant the ship when we plant the tree.*

*What do we plant when we plant the tree?
We plant the houses for you and me.
We plant the rafters, the shingles, the floors.
We plant the studding, the lath, the doors.
The beams, the siding, all parts that be.
We plant the house when we plant the tree.*

*What do we plant when we plant the tree?
A thousand things that we daily see.
We plant the spire that out-towers the crag.
We plant the staff for our country's flag.
We plant the shade from the hot sun free.
We plant all these when we plant the tree."*

I have always been interested in agriculture, but after twenty years of farming I decided to get into industry and make some money. After ten years in the steel mill, my health began to fail and my family doctor suggested my wife and I buy some land and do a little farming to keep busy. We bought 130 acres in Bradford County, with a good barn, but with no house. This land was unproductive with rolling hills. I contacted soil conservation

people and they gave us some help and suggested we contact the service forester for our county. The forester suggested planting trees, so we had him draw up a plan for various types of trees for our soil and area. We decided on Red Pine, Japanese Larch, European Larch, Norway Spruce, White Spruce, European Alder, Black Locust and Hybrid Poplar. We ordered these seedlings from Penn Nursery, Pennsylvania Forestry Department. In three years we planted 100,000 trees of these varieties that we purchased from the state. We also planted 50,000 different trees that we bought from a private nursery. They were Scotch Pine, Ponderosa, Blue Spruce, Con-Color Fir, Canadian Balsam, Black Walnut and Chestnut. We also planted bushels of Black Walnut Seeds, Hickory Nuts, Oak Acorns, Horse Chestnuts and Hazel Nuts. To plant all of these trees we bought a used Ford Tractor and a one row tree planter that was tough enough to take our stony soil.

We planted 10,000 Hybrid Poplar cuttings. These cuttings were planted in plowed ground as suggested by our forester. We plowed in the fall and planted cuttings the following spring. These cuttings all heaved or popped out of the ground the next spring. This required a replanting and we saved about 80%. I believe if this land was left fallow for two years a replant could have been avoided.

We also have thirty acres of native timber. We logged these acres ourselves and sent the logs to a sawmill and built our own hoe of these native White Pine, Hemlock, Ash, Oak and Maple. Among all of our trees is a two and one-half acre stocked pond that we love to fish. Our land also provides us with excellent deer hunting which we also enjoy.

Our trees are planted in sections within a boundary of original stone fencing that is used as a fire barricade. We also have roads around all sections so a four wheeler can get thru. Our roads are mowed two or three times a year and as needed. A second pond is under way and we hope to complete it in 1979, if we are able to clear storm damaged trees. We also have about 200 feet of woods road to improve.

Why a tree farm? Trees do not require the tender loving care that is necessary with farm animals, and you can come and go with freedom. But, tree farming still requires a considerable amount of work. Our Red Pine are all trimmed six feet and our Larch are trimmed twelve feet, which is no easy task. We have all but twenty acres trimmed, later we will start thinning. Tree farming can be a paying operation because of three reasons: firewood, pulpwood, and maple syrup. (We tap some 20 or so sugar maples.) Tree farming, for us, was a planned retirement, and we are always busy trimming, thinning, and cutting firewood, plus cutting browse for wildlife. At the present time I am taking a correspondence course in Wildlife Resources and the Natural Environment. To foster this idea, we have limited hunting on our tree farm. If I was physically able, I would buy a small sawmill to cut and sell rough lumber. With thirty acres of native timber, and the price of lumber, we could make a few dollars with good forest management. We took a thinning cut of hardwoods in 1960-61-62 and built our house. These same thirty acres are now ready for a second cutting. It is my opinion that tree farming, if properly cultivated and harvested, can be a paying operation. I would like to see more emphasis put on tree farming by federal, state and private industry. When driving

FORESTERS LOSE A FRIEND

through Pennsylvania, we see thousands of acres of unproductive land. These acres could all be raising trees. The amount of waste in the wood or timber operations is tremendous. We must learn to use everything as in the meat packing business where they use everything but the squeal. We have all seen timbered areas that look like a cyclone hit the area. This gives the logging industry a bad name, and as a tree farmer I am hesitant to have my woods clear cut and left to look like a shambles. I have several questions: 1. Why was it necessary for me to ask to become a Tree Farmer? 2. State nurseries lack information on seedlings. (Where can we get or purchase such seedlings as Canadian Balsam, Cyprus, Persimmon?) 3. Are the 4H Club pushing Tree Farms?

It was very easy for my wife and I to answer the question, "Why a Tree Farm?" Where else could we have gotten such an enjoyable retirement and at the same time helped our environment and wildlife? We could not have asked for more.

Robert W. Karn, Sr.
R. D. #3
Wyalusing, PA 18853

During the past two years foresters have been saddened by the loss of two outstanding individuals of national stature. First Ben Roach and now Dr. Roger Latham. Both individuals had the ability to deal with complex problems yet could take the time to explain them in terms the ordinary layman could understand.

While Dr. Roger Latham was not a forester, he worked closely with our profession. Dr. Latham earned a Bachelor Degree in Zoology and a Masters and Doctors Degree in Wildlife Management all from Penn State. He served for many years as Research Chief of the Pennsylvania Game Commission and for the past 22 years has been outdoor editor for the Pittsburgh Press.

Dr. Latham was killed Tuesday, May 15, 1979 when he slipped and fell while taking photos of mountain goats near Interlaken, Switzerland.

Dr. Latham gave unhesitatingly and unselfishly of his time and talents to those causes in which he believed. He recognized the problems associated with the large deer herd and one species management. When asked by foresters in the Plateau and Northern Hardwood Chapters to share his expertise on the deer problem at SAF functions, he willingly served as a key note speaker for the seminar in Ridgway, as a panelist on a Pittsburgh TV talk show, as a lecturer at the Boyce Campus open house and as a participant in legislative hearings.

Dr. Latham was respected and honored by foresters, sportsmen and his fellow journalists. He will be surely missed.

Friends of Dr. Latham have established the Roger Latham Memorial Fund which will be used for educational scholarships. Anyone wishing to donate to this worthwhile cause should make checks payable to the Roger Latham Memorial Fund and send them to the Latham home at R.D. #1, Gibsonia, Pa. 15044.

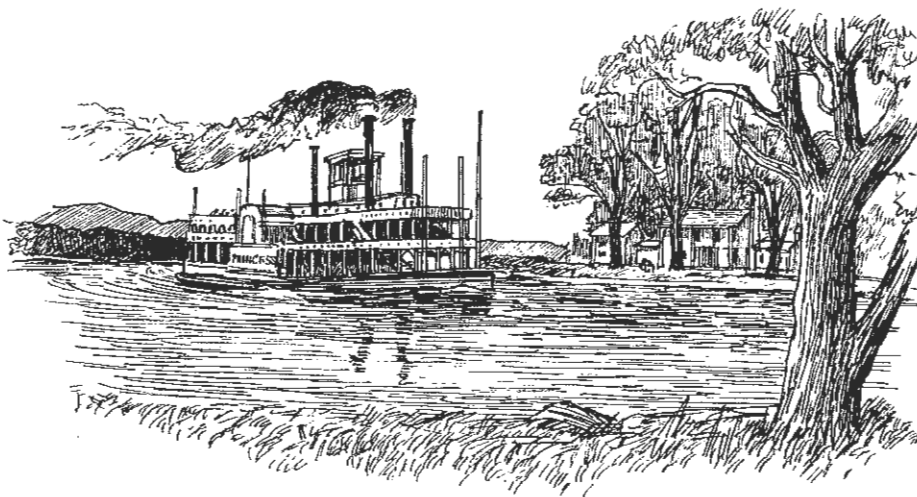

WHO, ME?

**CONTRIBUTE TO THE
FORESTERS' FUND?**

Here is my contribution of \$ _____ to the
Foresters' Fund, 5400 Grosvenor Ln., Wash-
ington, D.C. 20014.

NAME _____

ADDRESS _____

ZIP _____

SAF SECTION _____

SOCIETY OF AMERICAN FORESTERS ALLEGHENY SECTION

February 8, 1979, Stouffer's Valley Forge Hotel, King of Prussia, Pa.

The annual Business meeting of the Allegheny Section, Society of American Foresters, was called to order by Section Chairman George Kemp at 3:40 p.m.

The Minutes of the 1978 summer meeting held September 15 in Ocean City, New Jersey, were read by Richard Kennell and were approved as read.

The Treasurer's Report for the period December 1, 1977 through November 30, 1978 was read by Richard Kennell and approved.

Joseph Barnard reported that the Audit Committee found the Treasurer's records correct and in order. The report was approved.

Copies of the following Executive Committee Reports presented are available from the Secretary and summarized here:

1) Membership Committee - Kenney Funderburke

The net loss in Section membership is approximately 30 for the year. Current Section membership is 1200 as of 1/5/79.

An attempt was made to reinstate those who have dropped membership - 246 letters were prepared and mailed with only 10 positive responses to date.

Nationally, membership increased by 115 to a present total of 21,343.

MOTION — made by Mr. Funderburke and was carried that "The Allegheny Section initiate for an initial period of two years, to terminate on the date of the Business Meeting at the Winter meeting in 1981, a program of dues assistance to and for unemployed former student members of the Allegheny Section. Such assistance shall be in the form of a check issued by the Allegheny Section, payable to the Society of American Foresters, for the amount equal to the difference between Student Member dues and Member dues, and shall be effected only upon request for same to the Section by the former Student Member."

It is estimated to cost the Section a maximum of \$300.00 per year.

2) Society Reorganization - W. Scherer

No formal report was made. Chairman Kemp summarized the reorganization data from 1/18/79 newsletter and urged everyone to keep up-to-date on reorganization.

3) Forest Policy - R. Forney

No formal report. However, Alaska D-2, and RARE II policy statements are in the Journal of Forestry.

4) Public Affairs - B. Schick

No formal report. Plateau and Northern Hardwoods Chapter used National fund dollars to sponsor field trips related to deer browse and deer management problems in northwestern Pennsylvania. Applications of this year's funds should be sent to Schick by 9/30/79.

5) Legislation - J. Pflieger

An excellent report was made to the group bringing all up to date on national legislation affecting forestry. Again, we were urged to read the Journal of Forestry under National Highlights and Focus on The Issues.

Standing Committee reports were presented and are summarized below:

A. Section Affairs

1) Arrangements/Program - R. Langford

91 members were pre-registered for the meeting
149 total registration as of 2/8/79
120 members, 22 students, and 7 wives make up this total

2) Awards - H. Geiger

50 members will be honored at the Banquet. Henry Clepper will make the awards

Award procedures will be sent to each Chapter.

3) Forester Fund - L. Alpaugh

No report --

It was moved, seconded, and carried to have the Section donate \$1,000.00 to the Foresters Fund. This has been done.

4) History - W. Corlett

There is a need for old photos or special interest items for the history files.

5) Newsletter - R. Walcutt

Publications have been largely subsidized by Hammermill Paper Company on a different format. Many fine comments have been received on the new style. The editor needs more articles, pictures and news, and suggestions.

Circulation of the Newsletter is 1400.

B. Technical Subjects

6) Professional Registration and Licensing - K. Swartz

Chairman Kemp discussed the content of Swartz' report and can best be summarized by these three paragraphs from his report.

"My impressions are that there is a scattering of highly interested individuals across the state. They do not necessarily agree on licensing vs. registration, but they do feel that there is a real need for some action. At one time I had a relatively firm commitment for professional assistance in preparing an acceptable bill combined with the strong thought that there would be good enough contacts to have it presented in both Houses of the General Assembly.

"I have not pursued that action because most of the responses from the working foresters have been nothing more than a passive approval of the concept. There has also been a number of men opposed to the concept. Nobody has acknowledged my comments with regard to donation of funds to help push this idea to completion.

"In light of the above, I must admit that some of my personal enthusiasm has waned even though I am personally familiar with circumstances where local zoning ordinances have been passed on the subject of professional assistance for timbering, cutting trees, and the like. I have also had personal experience with a local planning commission recommending zoning of these types of practices and experienced, two times, circumstances where hydraulic engineers dictated logging practices."

7) Education - J. Hale

Technician voting rights were discussed. This issue will be submitted to the membership for final vote.

Accreditation - H. Moser

Accreditation standards for two-year associate degree programs in forest technology were reviewed.

He offered to discuss these at Chapter meetings and has copies available on request.

8) Entomology/Pathology - J. Kegg

Indication is that parasites are not an effective method to combat the Gypsy moth problem.

Dan Kucera indicated that use of 2-4-5-T is on a rapid decline here in the northeast.

9) Fire Control - R. Davey

In the 5—State area, the leading cause of forest fires is incendiary, with children and debris burning topping the list. Professional foresters have a good opportunity to provide information and to educate people in presenting wildfires. We must use the opportunity whenever we can. In this Section of SAF, there were 4,756 wildfires burning 43,291 acres. Each fire was a missed wildfire prevention opportunity.

10) Natural Areas - J. Pelurie

No report given

11) Tree Improvement - C. Hunt

The Committed reported that a review had been made of a publication on Pitch and Loblolly hybrids by Dr. Silas Little of the Northeastern Forest Experiment Station.

No resolutions were received from the floor.

Special Reports were presented on:

1) Maurice K. Goddard, Chair in Forestry and Environmental Resource Conservation.

Paul Felton announced that the Chair is being established at Penn State to honor Dr. Goddard. A committee has been named to raise 1 million dollars to endow the Chair.

All members were asked to contribute to this project. Checks may be sent to: *The Goddard Chair, 100 Old Main Pennsylvania State University, University Park, Pa. 16802*

2) R. D. Forbes - Testimonial

Paul Felton read he testimonial and it is appended to these minutes. Paul read a resolution (appended) memorializing Fellow R. D. Forbes. The resolution passed unanimously.

3) National Representative Dr. Warren Doolittle reported on the following issues:

- a) The Journal of Forestry will soon have a Student Column.
- b) The Foresters Fund amount to nearly \$500,000. The interest from this fund is used to finance exchange students, field trips, education projects, etc. The budget for 1979 is \$15,000.
- c) The SAF Science Program has a full-time Director - Carl Berntsen.

d) Schedule for future SAF National meetings is:

1979 Boston, Mass.
1980 Spokane, Wash.
1981 Orlando, Fla.
1982 To be made
1983 Portland

e) SAF Council approved an 85,000 square foot building for the Renewable Natural Resources Foundation at Wild acres.

f) Dr. Doolittle discussed and urged all of us to keep track of the SAF reorganization activity by reading the 6 installments in the coming issues of the Journal of Forestry.

No new business.

Chairman Kemp announced:

- 1) He has created a Soils Working Group with V. Miles as Chairman.
- 2) He is looking for a Coordinator for "The Year of The Student."
- 3) He needs a Chairman for a Marketing Group.
- 4) Next two winter meetings are: 1980 Pittsburgh
1981 Baltimore
- 5) S.W. Pa. Chapter is now the Western Gateway Chapter.
- 6) A moment of silence was observed for the following members who deceased in 1978: Dave Roche,
John Selinski

Chairman Kemp thanked all who were responsible for the arrangements and program.

Richard A. Kennell
Secretary/Treasurer

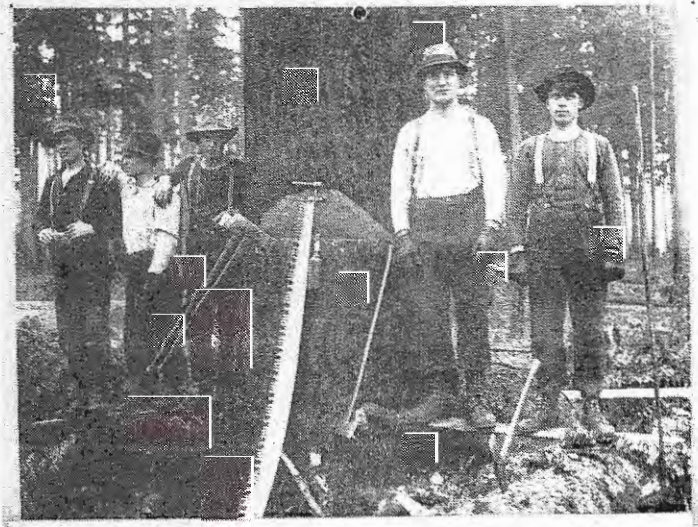

REMEMBER WHEN?

Allegheny Section Summer Meeting

Canaan Valley Resorts, Davis, West Virginia

August 29, 30 & 31, 1979

Located in a magnificent valley 3,000 feet above sea level, Canaan Valley provides the perfect spot for resort-style vacations. Surrounding mountain peaks rise to 4,200 feet or more offering spectacular, rugged scenery.

Featuring a complete winter sports complex, an outstanding 18 hole golf course with snack bar and gift shop, a heated swimming pool, six lighted tennis courts, hiking trails, and fishing, Canaan Valley is one of West Virginia's finest year-around recreation centers. Accommodations will be at Canaan Valley Lodge with deluxe conference center which offers a wide range of audio-visual equipment, restaurant with a seating capacity of 500, Cocktail Lounge and gift shops. There are also 15 deluxe cabins and 34 deluxe campsites with a country store. At nearby Blackwater Falls State Park, boating, horseback riding and more breathtaking scenic views are featured.

Nestled in the Appalachian Highlands of Eastern West Virginia, Canaan Valley is within easy driving distance of Pittsburgh, Washington, D.C., and major population centers of Ohio and the Eastern Seaboard.

PROGRAM OF ACTIVITIES

WEDNESDAY — August 29

5:00 - 7:00 p.m. Registration

6:00 P.M. Icebreaker

THURSDAY — August 30

9:00 - 4:30 *Land Management, History and Controversy in Canaan Valley, Davis, West Virginia.*

Tour of Canaan Valley to observe the effect of past and present uses, including intensive recreational development, timber management operations and wilderness. Members will also view a proposed power project site or possible wildlife refuge, and discuss the conflicting resource allocation.

12:00 - 1:00 *Lunch on your own in Davis, West Virginia.*

5:30 *Social hour.*

6:30 *Buffet dinner. Guest speaker will be Maurice Brooks, Professor Emeritus, Wildlife Management, West Virginia University and noted authority on natural and human history of West Virginia and Appalachia.*

FRIDAY — August 31

9:30 - 10:30 *Allegheny Section Summer Business Meeting.*

An optional tour of the Fernow Experimental Forest conducted by Clay Smith, U. S. Forest Service, Parsons, West Virginia, will be available Wednesday and Friday. Those interested should contact Clay by writing the Fernow Experimental Forests, Parsons, West Virginia 26287, or call 304/478-2000. There are many ongoing timber and watershed management research projects to see and the time and make-up of the tour will be tailored to members expressed interest.

**PLEASE NOTE: TO BE GUARANTEED
RESERVATIONS SHOULD BE RECEIVED
BY AUGUST 13, 1979**

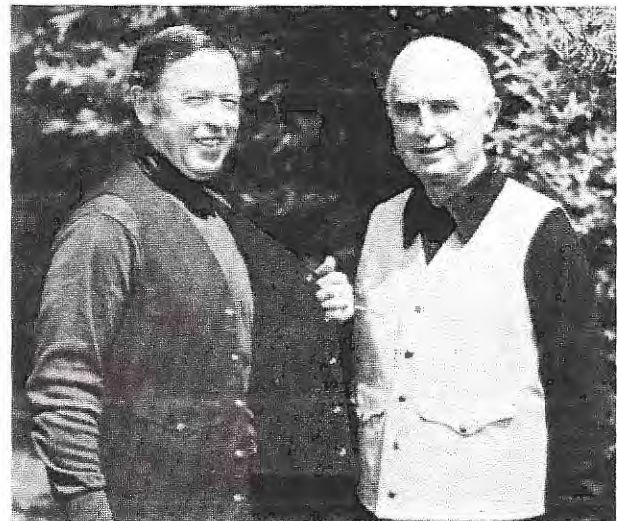

ORIGINAL FILSON CRUISER VEST

Three of a Kind

"More pockets than a pool table — Count Them!"

Lot 8 Khaki Fil-Duck Cruiser Vest

Lot 10 Red Poplin Cruiser Vest

Lot 12 Blaze Orange Safety Cruiser Vest

REQUEST YOUR COPY OF OUR NEW 79 CATALOG!



ART INKSTER

GENERAL SUPPLY CORP. ★ ★ ★
BOX 9347 ★ ★ ★
303 COMMERCE PARK DR.
JACKSON, MS. 39206
601-981-3882
1-800-647-6450

EXECUTIVE COMMITTEE MEETING - FEBRUARY 8, 1979

STOUFFERS HOTEL

VALLEY FORGE, PENNSYLVANIA

The winter business meeting of the Executive Committee, Allegheny Section, SAF, was called to order by Chairman George Kemp at 9:30 p.m.

After discussion, the Secretary-Treasurer was instructed to pay the following bills or expenses:

- 1) The Foresters' Fund - \$1,000.
- 2) Summer meeting deficit to New Jersey Chapter of \$279.86.
- 3) The Hammermill Paper Company for the Allegheny Newsletter (2 issues) - \$660.00.
- 4) Steve Holbrook for the Mangement Seminar at Winter Meeting - \$1,000 plus expenses.
- 5) Contribution of \$50.00 to Chairman of SAF, HSD, A. Temple Bowen for our share of his HSD expenses.

As of November 30, 1978, the total balance of Allegheny Section Treasury was \$9,643.52.

As in 1979 the Executive Committee agreed to reimburse each of the Forestry schools in the Section up to \$50.00 to help defray expenses for forestry students to attend the 1980 Winter Meeting, if requested to do so.

The Chapters were asked to alert members that action will be taken at the Summer Meeting whether or not to contribute \$1,000.00 toward the Maurice K. Goddard Chair in Forestry and Environmental Resource Conservation to be established at the Pennsylvania State University as discussed by Paul Felton at the general business meeting.

The Executive Committee agreed that the Section will reimburse the Section Chairman and Chairman-Elect for the attendance at the National SAF Convention in Boston in 1979, and the Chairman only to attend the mid-year HSD meeting, if called this year.

Chapters were reminded to submit names resulting from recent elections to Chairman Kemp and Secretary-Treasurer Kennell.

The following meetings are scheduled:

Summer 1979 .. West Virginia will host.
 Winter 1980 Western Gateway Chapter to host.
 Summer 1980 Unscheduled.
 Winter 1981 Baltimore Area.

A possible theme for the 1980 winter meeting is the addressing of several interfaces concerning foresters. One example would be the interface between logger and forester. Chairman Kemp will work with the Western Gateway Chapter on this theme.

Respectfully submitted,

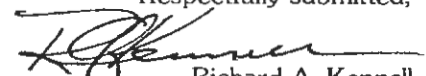

Richard A. Kennell
 Secretary-Treasurer

Ever see a Change Saw?

It could be your plain old Chain Saw, changed into a lumbermill,

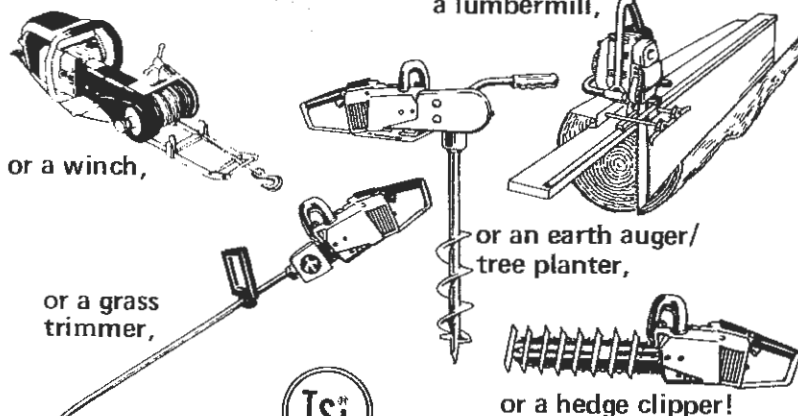

makes life easier & saves money, too!

TSI Co., Box 151, Flanders, NJ 07836
 Call Collect: (201) 584-3417

Write or call today for further details on Chain Saw changing, and for our big New 230 pg. Catalog featuring Environmental Science, Land Management, Forestry, and Ground Maintenance Tools and Equipment.

Name _____
 Address _____
 City _____ State _____ Zip _____
 Send my TSI Catalog Today, FREE!

NEWS FROM AROUND THE SECTION

KEYSTONE CHAPTER

The Keystone Chapter presented awards to two students of the Mont Alto Campus, Penn State University. A one year technician membership in the SAF was awarded to the outstanding, graduating Forest Technician, Richard Kinsch of Horsham, PA, and a one year student membership was awarded to the outstanding, second year baccalaureate forestry student Pamela Edwards of Palmyra, PA. The presentations were made at the Mont Alto Campus' Awards Day, May 6th, by Chapter Chairman Jim Pflieger.

Following the past practice of touring local wood using industries, the Chapter is planning a tour of the York-Hoover Casket Company, York, PA. York-Hoover uses some of our finest grade, native hardwoods, as well as a few exotics in the manufacture of burial caskets. A good end use for quality Red Oak! Plans are for members to enjoy a steak fry following the tour at Glatfelter Paper Company's lodge.

The spring Keystone Chapter meeting was held on April 24th at the University Lodge, Shippensburg. Thirty-three members and guests attended.

Bob Rumpf distributed copies of the proposed "Timber Harvesting Model for Pennsylvania". Bob then led a discussion on the status of the proposed guidelines. After a lively session it was decided that the chapter should submit recommendations to the sponsor of the model, the Pennsylvania Forestry Association. Charlie Johnson chaired a committee for this purpose and the Chapter's recommendations were forwarded to the P.F.A. on May 18th.

Alex Day
Jim Pflieger



Robert H. Rumpf, left, Pennsylvania District Manager, The Glatfelter Pulp Wood Company, Spring Grove, Pennsylvania, accepts the 1978 Company Project Award from Mrs. Maxine Morrison, Coordinator of the National Arbor Day Foundation's award ceremonies and Mr. Phillip Thornton, Deputy Chief of the U.S. Forest Service. This national award was made to the Company in recognition of its continuing reforestation project in south central Pennsylvania and for providing tree seedlings to York County, Pennsylvania schools for Arbor Day plantings. The award was presented to the Glatfelter firm during the National Arbor Day Foundation's annual award ceremony in Nebraska City, Nebraska in April.

KEYSTONE CHAPTER FIRE WARDEN ROWLAND DIES

Horace B. Rowland, 85, Pennsylvania's second Chief Forest Fire Warden, died in his Camp Hill home January 19.

He served the Commonwealth in that capacity and as Chief of its Forest Fire Protection Division in the former Department of Forests and Waters, now part of DER, from 1946 through July 1962.

A graduate of Pennsylvania Forest Academy, now part of The Pennsylvania State University, Rowland initially joined the State in 1915. He was one of four Forest Fire Wardens honored in the fall of 1975 for 60 or more years service.

H. B. Rowland Heliport, Monroe County, is named in his honor. He was a World War I veteran.

Among his survivors, who include a son, four grandchildren and six great-grandchildren, is his widow, Charlotte K. Rowland, a Clerk Stenographer serving as Secretary to Eugene F. McNamara, Chief, DER Division of Forest Fire Protection.

MARYLAND CHAPTER

Adna "Pete" Bond, retired Director of the Maryland Forest Service, received special recognition at the Maryland Chapter Winter Meeting. Pete received a plaque from the Chapter for his "outstanding service to forestry." Those of us in Maryland and throughout the Section particularly savor our warm relationship with Pete. Pete has done his best to instill in us that, as foresters, we are fortunate to be working with both trees and people, and they are both equally important.

Phil Pannill chaired a successful raffle to help pay for our chapter newsletter costs. Donna Gates sold the winning ticket.

Ernest P. "Red" Ogden, Junior Manager of chip procurement for Westvaco's Wood Procurement Department at Luke, recently received a national Pulpwood Logging Safety Award at the American Pulpwood Association's Annual meeting in Atlanta, Georgia. He was presented the award for his work in Pennsylvania's Logging Safety Council and his contribution of ideas and efforts during that state's logging safety week.

Our summer meeting was held at Hagerstown Junior College and included tours of a home heated by a wood-fired boiler system and the Statton Furniture Company.

OSCAR D. BAILEY RETIRES

On September 30, 1978, Oscar Bailey, Redden State Forest Supervisor, retired from the Forestry Section, Department of Agriculture, State of Delaware.

Oscar went to work for the Forestry Section in 1934, under William S. Taber. He began as a laborer in the tree nursery, but became the supervisor within six months. After five years of

supervising the nursery Oscar became a State Forest Ranger, a title which he held until 1970, when he assumed the duties of managing Redden State Forest. Although Oscar's job title changed several times through the years, he still worked in and supervised the tree nursery. Oscar is well known throughout Sussex County as the Chief of the Redden Fire Control Unit and especially to the volunteer fire companies as Mr. Bailey with the fire plow.

Now, seventy years old, Oscar lives near Redden Forest where he operates a watch and clock repair business out of his new home. Although Oscar still spends some time at the Forest, his experience in nursery work, fire control, mechanical repairs and just general know how and common sense will be sorely missed.

Phil Mohler

PLATEAU CHAPTER

The spring meeting of the Plateau Chapter was held at the Voyager Inn of Franklin on April 26, 1979.

The following report of the Deer Committee was presented at the meeting:

(1) In March, a group of Society members from the Joint committee on deer-timber management met in Harrisburg with nine legislative committee heads from both the House and the Senate. The arrangements for the meeting were made by State Senator Bob Kusse. The executive Director and three other members of the Game Commission were invited to sit in on the meeting. One thing that the legislators were aware of was the damage done to farm crops, however they were unaware of the extensive damage the deer herd causes in our forests.

(2) The Forest Service and the Game Commission will cooperate on preparing a small booklet on the browsing effects of deer. The distribution method of the booklets has not yet been decided upon.

3) A committee of farm groups and foresters met at Penn State to put together a program on the damage done by deer to forests and farm crops. Terry Rader from Penn State was appointed to head up this committee.

(4) The antlerless season and numbers of permits have been tentatively set for this fall. The counties suffering the most damage will have an extra day of hunting, also the number of permits was substantially increased in most of the northern tier counties.

(5) The Society of American Foresters will have to cooperate with the Game Commission to sell the idea of fewer deer to the public. They must be made to understand that excessive deer browsing does cause damage, and that other wildlife species such as grouse and turkey will benefit from a herd more in balance with the habitat.

Bruce E. Sundquist, Outings Chairman of the Sierra Club's Allegheny Group, Pa. Chapter, was the guest speaker for the evening. He is the senior scientist at Westinghouse's Advanced Reactor Division in Monroeville.

The Allegheny Group was established in 1970. Two years later, the Pa. Chapter was formed to coordinate the various groups within the state which currently has 5000 members. National membership is now 180,000.

RARE II discussions between the Sierra Club and the U.S. Forest Service regarding potential wilderness areas in the Allegheny National Forest have been going on since the early '70s. Currently, the proposal is as follows:

High Priority Areas

Allegheny Front - 8,700 Acres
Hickory Creek - 9,400 A.
Tracy Ridge - 9,200 A.

Low Priority Areas

Cornplanter - 3,012 A.
Clarion River - 4,042 A.

For Future Study

Allegheny River Islands
(8 islands) - 368 A.
Minister Valley - 1,375 A.

Non-Wilderness

Heart's Content - 200 A.

How does the Sierra Club view the economics of the eastern wilderness proposals? According to the speaker, if all RARE II study areas in the northeastern U.S. (12 states) were declared wilderness, the per-capita cost of the Oil, Gas, & Mineral (OGM) rights involved would be approximately, 58¢ initially, and an annual cost of 15½¢ thereafter. The former is the amount needed for the OGM rights, excluding surface rights, and the latter represents the cost of fuel conservation measures to save the amount of energy involved. The loss of timber productivity would be about 2.9¢/capita/year. These figures are based on an area population of 56,750,000 people.

A summary of public opinion polls, Mr. Sundquist stated, has shown that people in the northeastern states are concerned primarily with vanishing wilderness; that they may never be able to visit such areas is of secondary importance to most of them.

Much debate ensued following the presentation, during which foresters in general were accused of being - among other things - political pawns and "a front for the timber industry".

While this meeting provided the impetus for increased communication and exchange of information, a meeting of minds may still be a long way off.

Jerry Magistrella

PLATEAU AND NORTHERN HARDWOODS CHAPTERS

A joint meeting of the Plateau and Northern Hardwoods Chapters will be held July 18, 1979, from 8:30 a.m. to 4:00 p.m. at Ridgway, Pennsylvania.

The group will meet at the Ridgway Country Club parking lot and picnic area. The program features a forest industries tour including Penn Tech Paper Mill, Louisiana-Pacific Veneer Mill, and Buehler Lumber Company Sawmill.

Dennis Edmiston

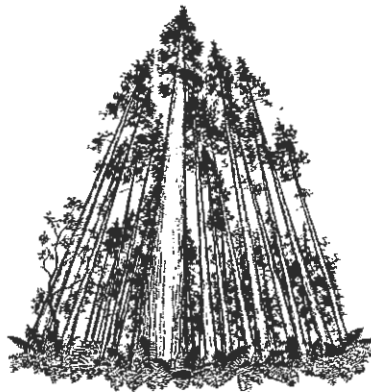

ROTHROCK CHAPTER

The whole affair seemed a bit fishy, but foresters who attended netted new insights on an important forest resource.

The Pennsylvania Fish Commission's "Water Inventory and Classification Program" was the central topic for Rothrock Chapter's May 4 spring meeting. An excellent presentation by the Commission staff described a radically new detailed classification and inventory system for Pennsylvania streams. Future stream classification will be based on all the major factors of stream ecology, and this classification along with fishing pressure will provide the basis for comprehensive planning and fisheries management.

A streamside demonstration of sampling techniques used in classification was given on the Logan Branch stream. This included water quality, chemical tests, collecting "critters", and electroshocking. Another attraction was a general tour of the Pleasant Gap hatchery facilities where over a half million stockable trout and a quarter million fingerlings are produced annually.

Following the main portion of the meeting, a T.G.I.F. session and dinner at the Robin Hood Inn provided a proper setting and atmosphere for informal forestry discussions and fellowship.

Sam Bricker



WEST VIRGINIA CHAPTER

The 1979 spring meeting of the West Virginia Chapter of S.A.F. was planned with the "old grads" of West Virginia University in mind.

Many new facilities are available at the University Forestry School that are not generally known to foresters throughout the state, especially in the area of forest technology and wood products. With this in mind, the WVU staff conducted a program explaining the current curriculum and anticipated needs for the school. A tour of the research and testing facilities was also provided.

The "old grads" were invited to remain in Morgantown to attend a meeting of the alumni association of the Forestry School the next afternoon. Topping off the weekend was the annual Forestry Club banquet held on Saturday night.

WEST VIRGINIA CHAPTER (continued)

New officers of the West Virginia Chapter of S.A.F., elected last fall and now serving, are:

Chairman Ralph Glover
W. Va. Dept. of Natural Resources
Division of Forestry
Vice-Chairman Ed Grafton
Glennville State College
Secretary-Treasurer Joe Newlon
Chief Forester, Chessie Resources

New Executive Committee members are:

Gill Churchill, Monongahela
National Forest
Gary Zinn, West Virginia
University
Clay Smith, U.S. Forest Service
Timber and Watershed Lab
Frank Groves, Westvaco, West
Virginia Woodlands

ALLEGHENY COMMUNITY COLLEGE

Dr. William L. Cones, Director of Forestry Programs at Allegany Community College, Cumberland, Md., reports that the Maryland State Board for Community Colleges has recently designated the ACC Forest Technology curriculum as a state-wide program. This means that ACC will have the only Forest Technician Program in the State of Maryland. Beginning with the fall 1979 semester, Maryland residents living out of Allegany County will be able to attend the Forest Technology program at ACC at a lower tuition rate than in previous years. Twelve forest technology students graduated from ACC in May of this year. Most of these have already found employment in the forestry field. Since the first Forest Technology graduating class in 1971, 156 students have graduated from ACC in this program. Graduates of the program are now employed by state, federal, and private organizations throughout Maryland and the U.S.

John Zipfel, correspondent for the Allegany Community College Forestry Club, reports that on Saturday, April 7, a brisk cold wind greeted the members of the ACC Forestry Club; the Dabney S. Lancaster Community College Forestry Club of Clifton Forge, Virginia; and the Williamsport Community College Forestry Club from Williamsport, Pennsylvania. It was time once again for the Annual Tri-State Woodsmen's Competition. The meet is held between area community colleges that have forestry technology programs at their schools. The event offers students and spectators a chance to see a fantastic show of the woodsman's skills. ACC's Forestry Club, this year's host, proved to be the victors in many of the events and also the overall winners of the Meet. The final outcome was ACC, 68 points; Dabney S. Lancaster, 45 points; and Williamsport, 40 points. The ACC team members were Jeff Nichols - team captain, Ken Gibbs, Gurney Crowe, Mark Nider, Tom Fields, Robby Cox, Roger Cardell, Brice Marden, Eric Blake, Steve Mayville, Glenn Edwards, and Karl Christensen.

Professionally-staffed forest information booths covering a wide range of subjects greeted participants in a woodland owner's seminar held at Allegany Community College in Cumberland, Maryland, on May 12th. The seminar, jointly sponsored by the Allegany County Cooperative Extension Service, the Maryland Forest Service, and the Westvaco Corporation, was aimed at providing area forest landowners with current information on forest resources and management. The principal speaker at the event was David G. Pritt, Extension Landscape Architect, University of Maryland, who presented thoughts and methods on the aesthetic management of woodlots - including harvesting to enhance beauty, layout of log roads, and recreational considerations.

_____ Rex Harper

PENN STATE, MONT ALTO

Doug Copeland, a graduating Forest Technician Student at Mont Alto received a 2nd place (\$500) award in the Northeastern Logger Essay Competition.



PENN STATE UNIVERSITY

The first southern forestry tour for students enrolled in the baccalaureate program in the School of Forest Resources is now history. Dr. "Bob" Shipman took ten forestry students (including two girl foresters) on a week's tour of various forestry activities being carried out in North and South Carolina. They visited Champion Timberlands Company, Westvaco, went through the pulp mill at Charleston, South Carolina and spent two days at Clemson Universities' Wildlife and Forestry field center, the Hobcaw Barony near Georgetown, South Carolina. Needless to say, voluminous notes were taken, many photographs and ticks, mosquitoes and chiggers were encountered. Bob had them up by six o'clock every morning! This is another "first" for Penn State -- experience gained from this trip will be invaluable for future trips.

A workshop for resource managers entitled "Evaluation of Timber Harvesting and Watershed Management Practices in Relation to Contemporary Environmental Standards" will be held September 12-13, 1979, at Penn State University, University Park, Pa. The purpose of the workshop is to present information which is useful in the management of forested watersheds in relation to contemporary environmental standards. Emphasis will be placed on on-site evaluations of best management practices designed to

control non-point source pollution from timber harvesting activities. A half-day indoor session will cover basic watershed management and hydrologic principles, current federal and state water pollution control and safe drinking water regulations, implications of such regulations on forest management activities, availability of resource information for land-use planning and decision making, and municipal watershed assistance programs.

The second day will be a field trip to the University's Leading Ridge Experimental Watersheds. The field trip will include on-site evaluation of the effects of experimental treatments (clear-cut-herbicide) on water yield and nonpoint source pollution as well as an evaluation of best management practice guidelines for commercial timber harvesting operations. Topics to be discussed during the field trip include sedimentation, turbidity, nutrient leaching, stream temperature, annual and seasonal discharge, storm flow, aquatic ecosystems, streamside management, and timber regeneration.

For further information, write to Dr. James A. Lynch, 311 Forest Resources Laboratory, University Park, Pa. 16802, or telephone (814) 865-8830. There is a \$10.00 registration fee and the deadline for registration is August 31, 1979. For Registration forms write to Debbie Noyes, The Penn State University, 410 Keller Conference Center, University Park, Pa. 16802, or telephone (814) 865-8820. Speakers during the morning session to include: Edward S. Corbett, Principal Hydrologist, Northeastern Forest Experiment Station USDA, Forest Service, James A. Lynch, Asst. Professor of Forest Hydrology, School of Forest Resources, The Pennsylvania State University, Karl Sheaffer, Chief, Aquatic Biology Section, Pennsylvania Department of Environmental Resources, Bureau of Water Quality Management, William E. Sharpe, Water Resource Specialist, Institute for Research on Land and Water Resources, The Pennsylvania State University,

George N. Coller, Area Conservationist, USDA, Soil Conservation Service, Karl A. Davidson, Staff Director, Area Planning and Management Assistance, Northeastern Area State and Private Forestry, USDA, Forest Service.

Field trip to be conducted by: James A. Lynch, Asst. Professor of Forest Hydrology, Penn State University; Edward S. Corbett, Principal Hydrologist, USDA, Forest Service; Paul McDonel, Forest II, Bureau of Forestry, Pennsylvania Department of Environmental Resources; Richalon L. Hoopes, Fisheries Biologist, Pennsylvania Fish Commission; Robert B. Hesser, Chief, Fisheries Management, Pennsylvania Fish Commission; Gregg B. Rishel, Graduate Research Asst. in Forest Hydrology, Penn State University; Keith E. Mussallem, Graduate Research Asst. in Forest Hydrology, Penn State University.

The McIntire-Stennis Cooperative Forestry Research Advisory Board has a new Chairman, Jay Hughes, Dean, College of Forestry and Natural Resources, Colorado State University. He replaces Richard Skok.

Bob Bond attended the Appalachian Technical Division, American Pulpwood Association, May 2 and 3 in Lynchburg, VA. He gave a paper on the assigned topic "Four Year vs. Two Year Forestry Education."

Henry Gerhold and Chris Sacksteder recently received a \$1000 award from the International Society of Arboriculture for their proposal "Selecting Trees for Urban Planting Sites." They published "A Guide to Urban Tree Inventory Systems" as School of Forest Resources Research Paper No. 43, March, 1979. This work was supported by the Forest Service, U.S.D.A., State and Private Forestry. They are to be commended for this very spiffy looking 52 page publication. Its content is also good as attested to by the Forest Service's laudatory letter.

Bob Wingard recently received a Certificate of Appreciation from the U.S. Forest Service "For conceptualizing and developing the film-o-graph motion picture -- Forests for Wildlife -- for use by private landowners to improve wildlife habitat and enhance timber growth." The film was chosen as one of the top three films of 1978 from a group of 19 outdoor films evaluated by The Outdoor Writers Association of America. Prints of the film were provided to the School of Forest Resources. Several faculty and students of the School of Forest Resources attended the North American Wildlife and Natural Resources Conference at Toronto, Canada in March. John George, Bond Wingard, and Bob Mitchell participated in special meetings on blackbird damage control, wildlife research unit programs, and wildlife extension education. Steve Liscinsky, Adjunct Asst. Professor, presented publication awards at the Wildlife Society meeting.



A logger named Paul couldn't see
The marks he had made
on a tree.
After a lot of complaint
he tried Nelson Paint
And now he is marking
with glee!

NELSON
PAINT COMPANY — P.O. BOX 907
IRON MOUNTAIN, MICHIGAN 49801
Three Plants to serve you!

1978-79 EXECUTIVE OFFICERS

Mr. Kenney P. Funderburke, Jr.
P O Box 685
Lewisburg, W VA 24901

Mr. Richard A. Kennell
713 Oxford Lane
Wallingford, PA 19086

Robert T. Forney
2015 Mona Court
Milton, W VA 25541

James E. Pflieger
Route 2, Box 149
Fayetteville, PA 17222

William D. Scherer
Route 1, Box 757
Frostburg, MD 21532

Bruce A. Schick
223 E Washington Street
Lewisburg, W VA 24901

Mr. James C. Nelson
1295 Kelton Road
Camp Hill, PA 17011

George R. Kemp, Chairman
633 Long Run Road
McKeesport, PA 15132

1979 CHAPTER CHAIRMEN

KEYSTONE

James E. Pflieger
R D #2, Box 149
Fayetteville, PA 17222

MARYLAND

Kenneth Willets
2271 Duval Road
Woodbine, MD 21797

NEW JERSEY

Paul Berezny
341 Pleasant Grove Road
Long Valley, NJ 97853

NORTHERN HARDWOODS

Robert W. Martin, Jr.
125 Elmwood Court
Emporium, PA 15834

PINCHOT

G. Nevin Strock
R D #2, Box 164J
Schuylkill Haven, PA 17972

PLATEAU

David E. Beale
Box 204
Worthington, PA 16262

WESTERN GATEWAY

E. Gary Scott
R D #3, Box 361
Ebensburg, PA 15831

ROTHROCK

Charles Strauss
1637 Princeton Drive
State College, PA 16801

VALLEY FORGE

John H. Kitch
R D #2
Reinholds, PA 17569

WEST VIRGINIA

Ralph P. Glover, Jr.
806 Daverton Road
Charleston, WV 24303

1978-79 COMMITTEE CHAIRMEN

ARRANGEMENTS Winter '80 Meeting

J. Lee Gillespie
R D #1, Box 223-1
Scottdale, PA 15683

AUDITING

Joseph E. Barnard
R D #1, Box 42
Chadds Ford, PA 19317

AWARDS

Harold W. Geiger
105 W Highland Avenue
Spring Gorge, PA 17362

EDUCATION

James A. Hale
P O Box 406
Mont Alto, PA 17237

ENTOMOLOGY - PATHOLOGY

John D. Kegg
R D #2, Box 544
Califon, NJ 07830

FIRE CONTROL

Robert F. Davey, Jr.
317 E. Highland Avenue
Ebensburg, PA 15931

FOREST POLICY

Robert T. Forney (E.C.)
2015 Mona Court
Milton, W VA 25541

FORESTERS FUND

G. Lester Alpaugh
R D #3, Box 322
Stockton, NJ 08559

HISTORY

William S. Corlett
51 Fort Street
Lemoyne, PA 17043

LEGISLATION

James F. Pflieger (E.C.)
Route 2, Box 149
Fayetteville, PA 17222

MEMBERSHIP

Kenney P. Funderburke, Jr. (E.C.)
Box 685
Lewisburg, W VA 24901

NEWSLETTER

Roxann Walcutt
Allegheny News
Box 452
Smethport, PA 16749

NOMINATING

James C. Nelson
1295 Kelton Road
Camp Hill, PA 17011

NATURAL AREAS

Franklin B. Pelurie
1574 Dixie Street
Charleston, W VA 25311

PARLIMENTARIAN

Robert J. LaBar
1820 West 56th Street
Erie, PA 16509

PROFESSION REGIST. & LICENSING

Kenneth D. Swartz
R D #2
Fayetteville, PA 17222

PROGRAM Winter '80 Meeting

Open

PUBLIC AFFAIRS

Bruce A. Schick (E.C.)
223 E. Washington Street
Lewisburg, W VA 24901

SOCIETY REORGANIZATION

William D. Scherer (E.C.)
Route 1, Box 757
Frostburg, MD 21532

TREE IMPROVEMENTS

Clyde M. Hunt U.S.F.S.
6816 Market Street
Upper Darby, PA 19082

(E. C.) Executive Committee Member